



STANDHEIZUNG
ENGINE - INDEPENDENT HEATING SYSTEM

BILDTAFEL
PICTORIAL DISPLAY

12.93

2227011-ETL A

1/2

GMK 5160
BE 752
G 291

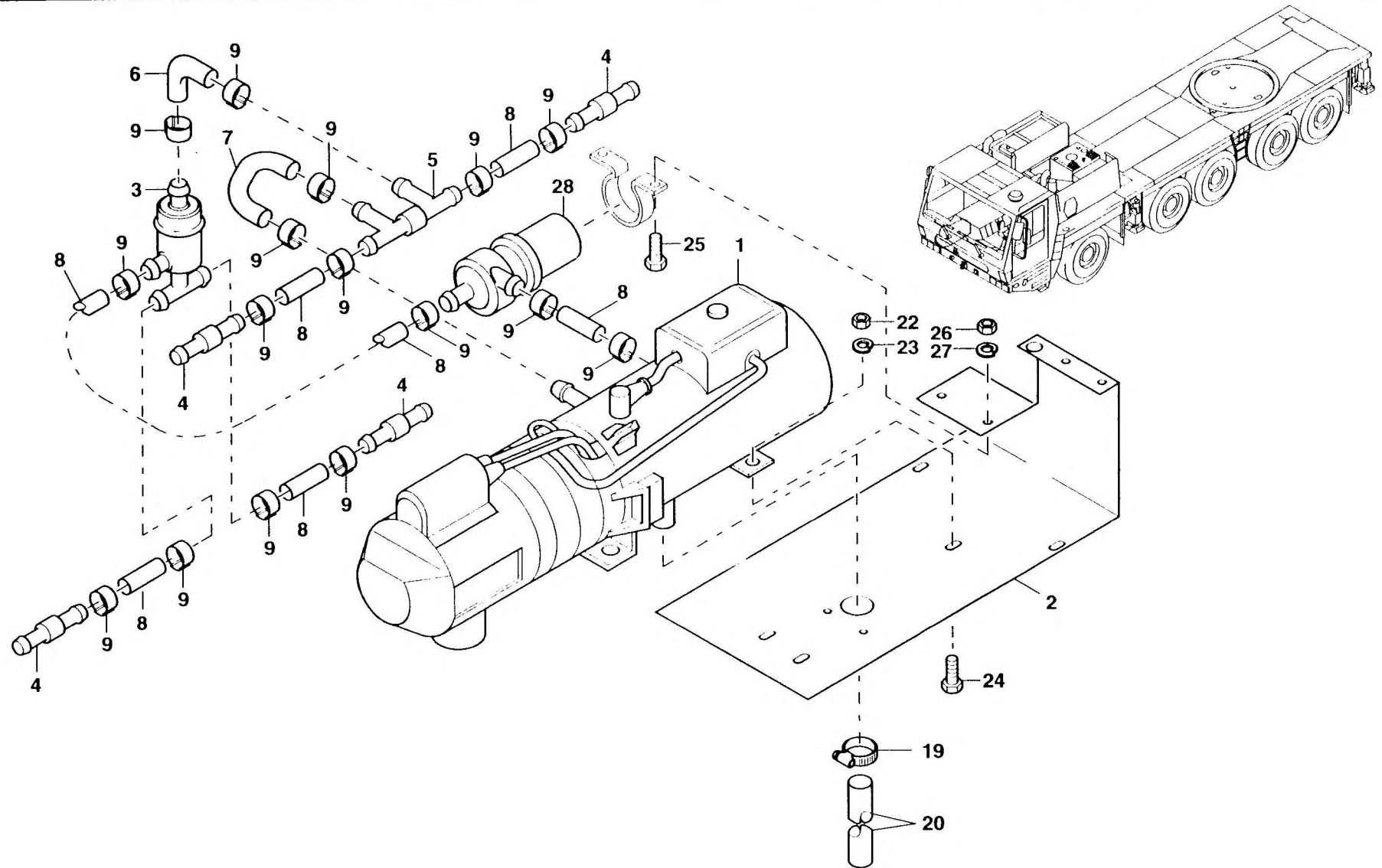



STANDHEIZUNG
ENGINE - INDEPENDENT HEATING SYSTEM

BILDТАFЕL
PICTORIAL DISPLAY

12.93

2227011-ETL A

2/2

GMK 5160
BE 752
G 291

